

Installation and Wiring Instructions

Temperature & Relative Humidity Sensor

Wired RS485 & Wireless RF868



This sensor is for background monitoring of temperature and relative humidity in the indoor air zone, providing RS485 wired & RF868 wireless control signals.



IMPORTANT: READ THESE INSTRUCTIONS BEFORE COMMENCING THE INSTALLATION



SAFETY AND GUIDANCE NOTES

- **WARNING:** must be isolated from the power supply during the installation / or maintenance.
- All wiring to be in accordance with the current I.E.E. Regulations, or the appropriate standards of your country and **MUST** be installed by a suitably qualified person.
- The siting and installation **MUST** comply with the current IET Wiring Regulations (BS7671 UK) or the appropriate standards in your country.
- This device is powered by 220-240V~50Hz
- The sensor should only be used in conjunction with fixed wiring.
- The cross - sectional area of supply cord used should be ranged from 1 -1.5mm².
- The sensor is a class II double insulated product and **MUST NOT** be earthed.
- **Wireless:** -14dBm EIRP nominal 868MHz.
- The manufacturer hereby assures that this 868MHz radio equipment complies with RED Directive 2014/53 / EU.

LOCATION AND INSTALL

- Avoid locations exposed to sunlight, above any heater, underneath ventilation units and proximity to doors and windows.
- Sensors should be located in the occupied zone (typically 1.5m above the floor).
- Ensure top and bottom of sensor has clear space for air intakes and access.
- Back plate to be installed while the front of the sensor remains inside protective packaging until system commissioning.
- Beware of fragile electronics and connector pins on reverse of sensor casing.

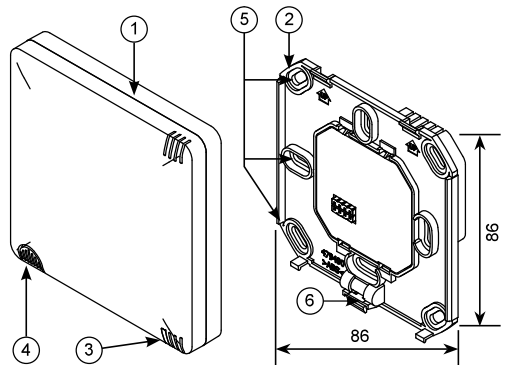





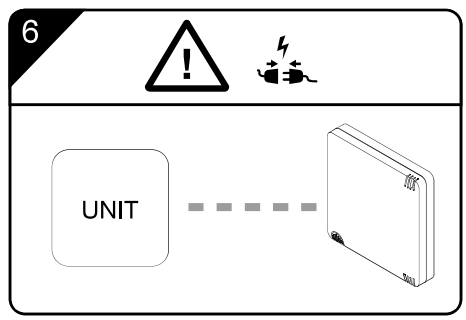
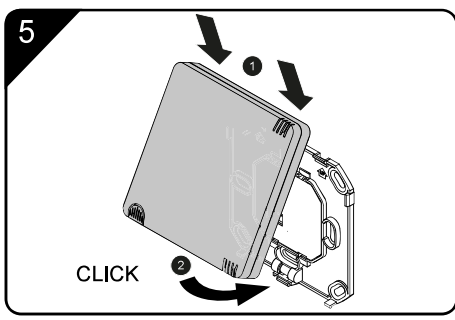
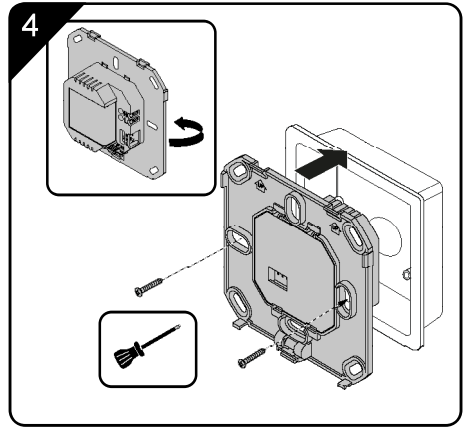
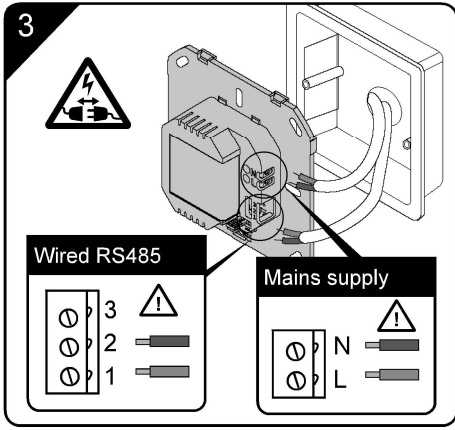
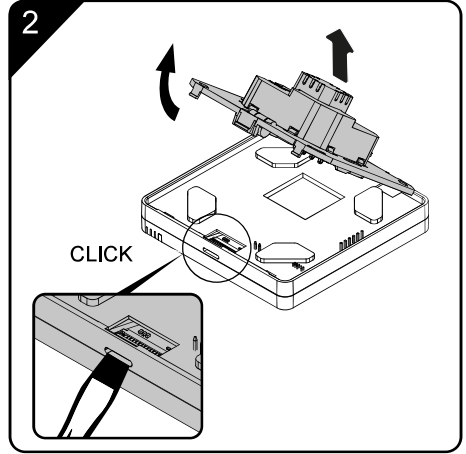
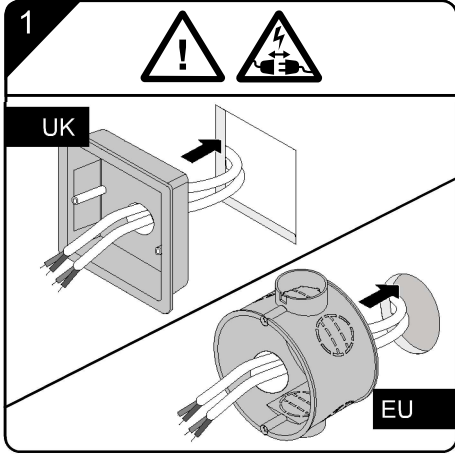
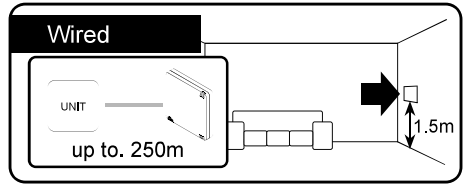
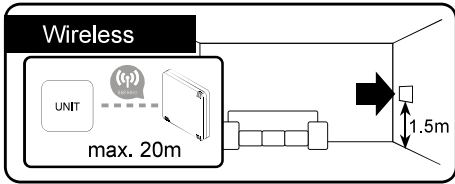

1. Casing with sensor electronics
2. Base plate with power supply
3. LED (Multicoloured)

4. Pushbutton for mounting
5. Fixing holes for mounting
6. Hook to snap into casing.



Key

						
Green	Red	Light Blue	Green Flashing	Red Flashing	Paired	Un-Paired

A - Wireless Pairing

A-1

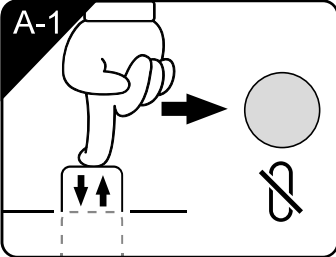

A-2

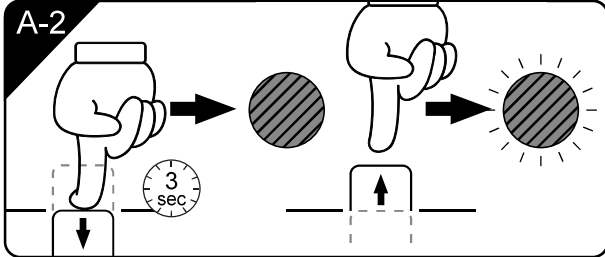

A-3

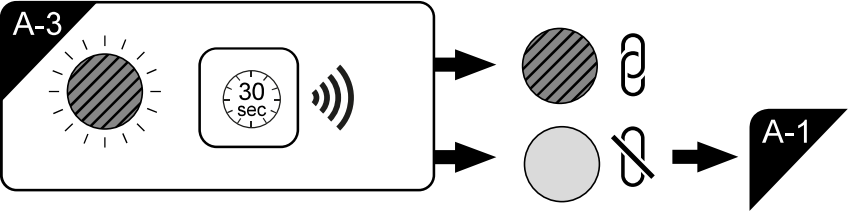

B - Reset

B-1

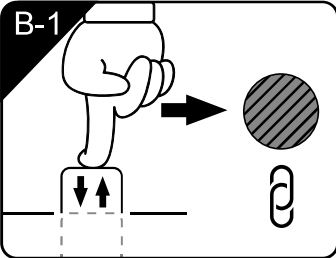

B-2

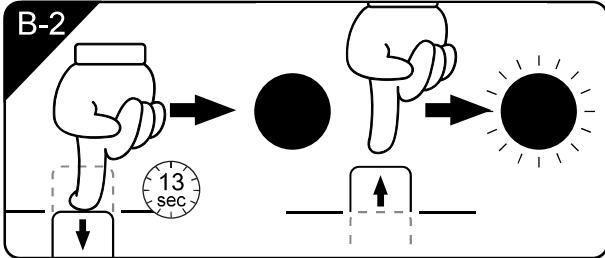

B-3

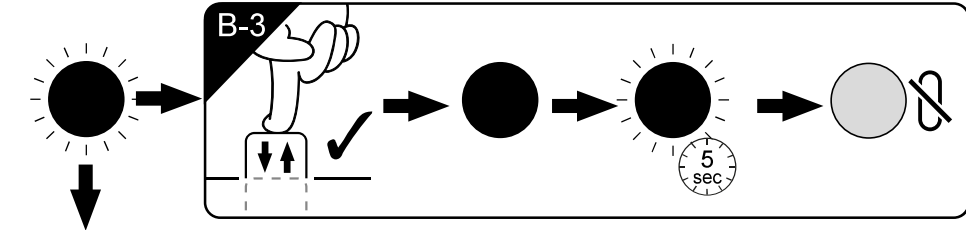
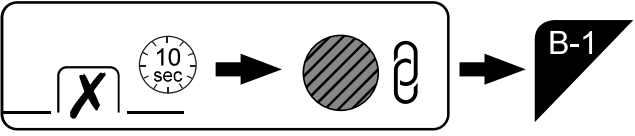
Technical data

Features	Values
Protection class (EN 61140)	II
Type of protection (DIN EN 60529)	IP31
Input voltage – Mains voltage [V AC/Hz]	230/50
Operating voltage [V DC]	5
Power consumption [W]	0.64
Power consumption (In standby) [W]	0.41
Radio frequency [Mhz]	868
Radio network range [m]	Free field: 100 / building: 20
Temperature measuring range [°C]	7 – 37
Air humidity measuring range [%]	20 – 90
Dimensions [H x W x D in mm]	90 x 90 x17



Disposal

This product should not be disposed of with household waste.
Please recycle where facilities exist.
Check with your local authority for recycling advice.

FOR CONTACT DETAILS PLEASE REFER TO YOUR UNIT MANUAL

Instructions d'installation et de câblage

Capteur de température et d'humidité relative Filaire RS485 et sans fil RF868



Ce capteur est destiné à surveiller la température et l'humidité relative dans la zone d'air intérieur ainsi qu'à fournir des signaux de commande filaires RS485 et sans fil RF868.



**IMPORTANT : LISEZ CES INSTRUCTIONS
AVANT D'INSTALLER LE PRODUIT**



REMARQUES DE SÉCURITÉ ET CONSEILS

- **AVERTISSEMENT** : les différents équipements doivent être isolés de l'alimentation électrique pendant l'installation ou la maintenance.
- Le câblage doit impérativement être conforme à la réglementation I.E.E. ou aux normes en vigueur dans votre pays et **DOIT** être installé par une personne dûment qualifiée.
- L'emplacement et l'installation **DOIVENT** être conformes à la réglementation sur le câblage IET actuelle (BS7671 UK) ou aux normes en vigueur dans votre pays.
- Cet appareil reçoit une alimentation de 220-240 V ~ 50 Hz
- Le capteur ne doit être utilisé qu'avec un câblage fixe.
- Utilisez un cordon d'alimentation présentant une section transversale comprise entre 1 et 1,5 mm².
- Ce capteur est un produit à double isolation de classe II qui **NE DOIT PAS** être mis à la terre.
- Sans fil : - puissance isotrope rayonnée équivalente de 14 dBm, fréquence nominale de 868 MHz.
- Le fabricant assure par la présente que cet équipement radio de 868 MHz est conforme à la Directive RED 2014/53/UE.

EMPLACEMENT ET INSTALLATION

- Évitez les emplacements exposés à la lumière du soleil, placés au-dessus d'un appareil de chauffage, en dessous d'un appareil de ventilation ou à proximité des portes et fenêtres.
- Les capteurs doivent être situés dans la zone occupée (généralement à 1,5m au-dessus du sol).
- Assurez-vous que les parties supérieure et inférieure du capteur sont dégagées pour assurer le bon fonctionnement des prises d'air et l'accès à l'appareil.
- La plaque arrière doit être installée tandis que la partie avant du capteur doit rester dans l'emballage de protection jusqu'à la mise en service du système.
- Attention, les composants électroniques et les broches de connexion situés au dos du boîtier du capteur sont fragiles.

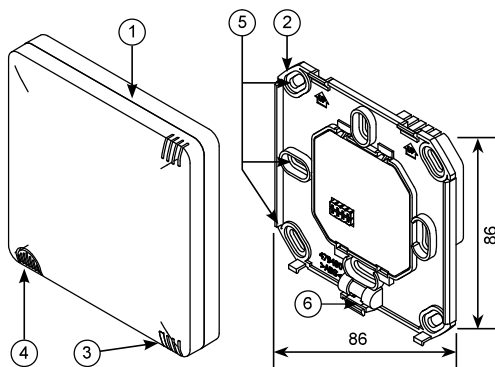

1. Boîtier contenant les composants électroniques du capteur
2. Plaque de base avec alimentation
3. LED (multicolore)
4. Bouton-poussoir
5. Trous de fixation pour le montage
6. Crochet à accrocher au boîtier.

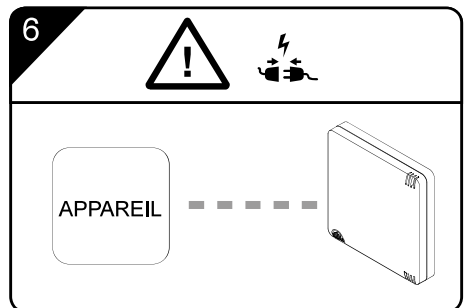
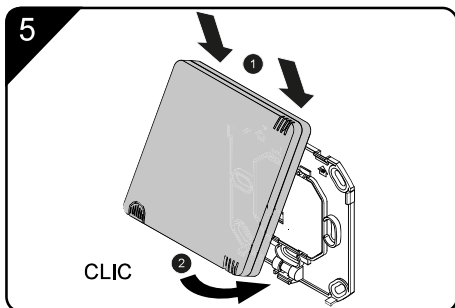
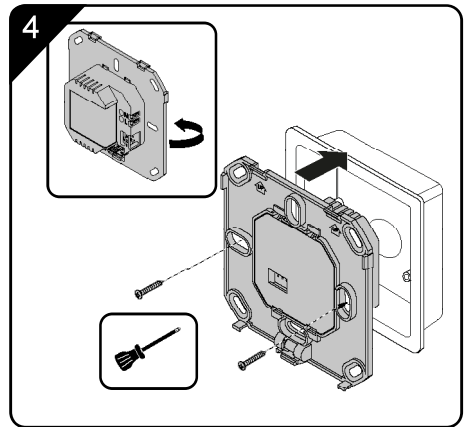
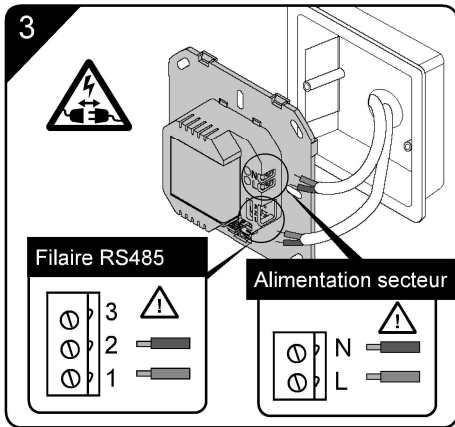
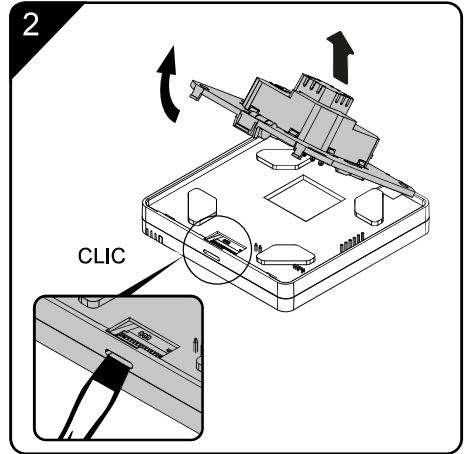
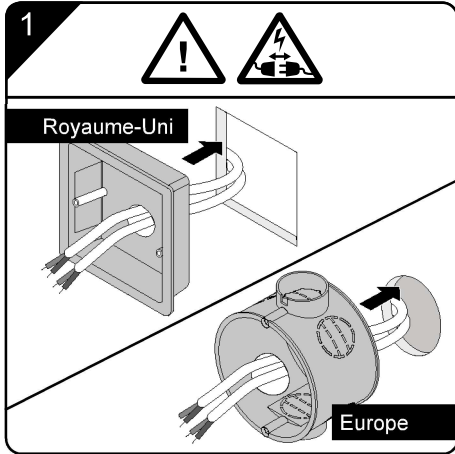
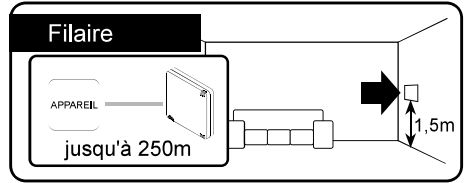
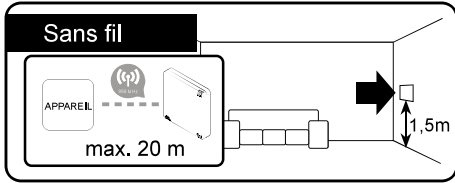

Bouton



Vert



Rouge



Bleu clair

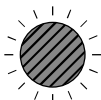

Vert clignotant

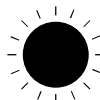

Rouge clignotant



Jumelé



Non jumelé

A - Jumelage sans fil

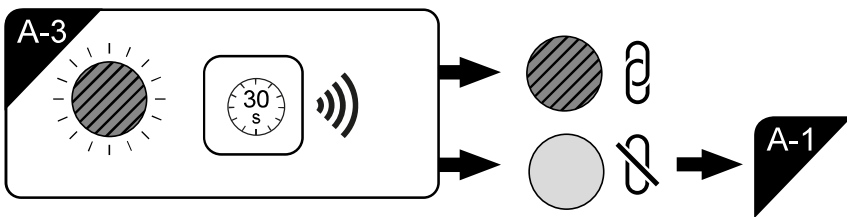
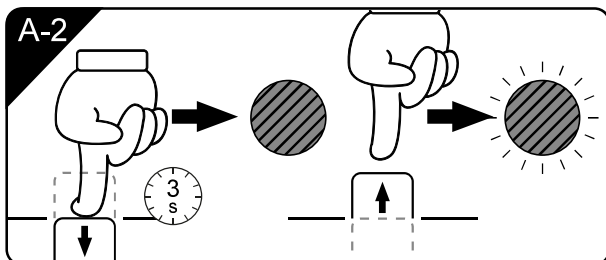
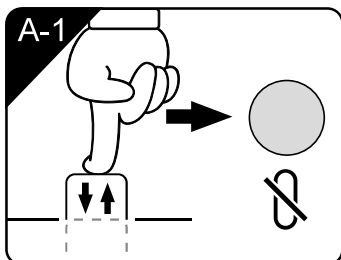

B - Réinitialisation

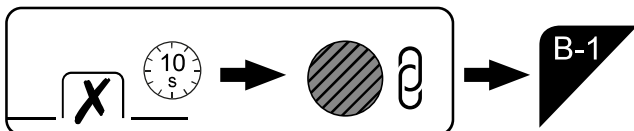
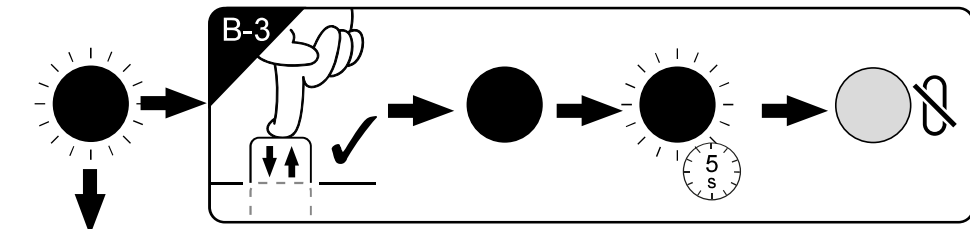
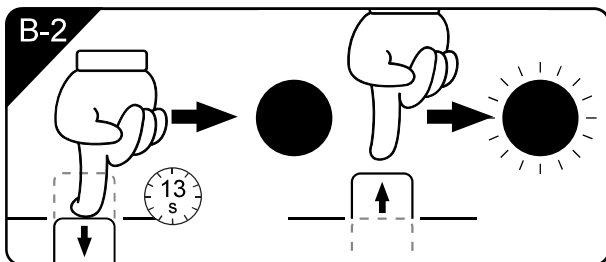
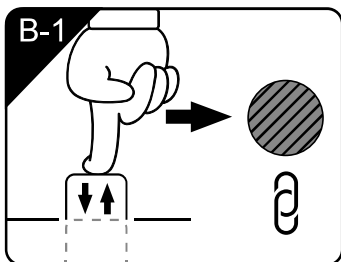

Données techniques

Caractéristiques	Valeurs
Classe de protection (EN 61140)	II
Type de protection (DIN EN 60529)	IP31
Tension d'entrée - Tension de secteur [V CA/Hz]	230/50
Tension de fonctionnement [V CC]	5
Consommation d'énergie [W]	0,64
Consommation d'énergie (en mode veille) [W]	0,41
Fréquence radio [MHz]	868
Portée du réseau radio [m]	Champ libre : 100 / bâtiment : 20
Plage de mesure de la température [°C]	7 - 37
Plage de mesure de l'humidité de l'air [%]	20 - 90
Dimensions [h x l x p en mm]	90 x 90 x 17



Mise au rebut

Ce produit ne doit pas être mis au rebut avec les ordures ménagères. Veuillez le recycler si des installations prévues à cet effet sont disponibles près de chez vous.

Contactez les autorités locales pour obtenir des conseils sur les procédures de recyclage.

POUR OBTENIR LES COORDONNÉES, REPORTEZ-VOUS AU
MANUEL DE VOTRE APPAREIL

Installatie- en bedradingsinstructies

Temperatuur- en relatieve vochtigheidssensor Bedrade RS485 en draadloze RF868



Deze sensor bewaakt de temperatuur en relatieve vochtigheid in de binnenluchtzone op de achtergrond, en levert bedrade RS485- en draadloze RF868-stuursignalen.



**BELANGRIJK: LEES DEZE INSTRUCTIES
VOOR U BEGINT MET DE INSTALLATIE**



VEILIGHEIDS- VOORSCHRIFTEN EN RICHTLIJNEN

- **WAARSCHUWING:** moet tijdens installatie of onderhoud worden geïsoleerd van de stroomvoorziening.
- Alle bedrading moet overeenkomen met de huidige I.E.E.- regelgeving of aan de van toepassing zijnde norm in uw land. bedrading **MOET** door een hiervoor opgeleide persoon worden geïnstalleerd.
- Plaatsing en installatie **MOETEN** voldoen aan de huidige IET-voorschriften voor bedrading (BS7671 UK) of aan de toepasselijke normen in uw land.
- Dit apparaat wordt gevoed door 220-240V~50Hz
- De sensor mag alleen in combinatie met vaste bedrading worden gebruikt.
- De diameter van de voedingskabel moet tussen 1 en 1,5 mm² liggen.
- De sensor is een klasse II dubbel geïsoleerd product en **MAG NIET** worden geaard.
- Draadloos: -14dBm EIRP nominaal 868MHz.
- De fabrikant garandeert hierbij dat deze 868MHz-radioapparatuur overeenstemt met de RED-richtlijn

2014/53/EU. LOCATIE EN INSTALLATIE

- Vermijd plaatsen die kunnen worden blootgesteld aan zonlicht, boven een verwarming, onder ventilatie-units en in de nabijheid van deuren en ramen.
- Sensoren moeten in de leefzone worden geplaatst (meestal 1,5 m boven de vloer).
- Zorg ervoor dat er aan de boven- en onderkant van de sensor vrije ruimte is voor luchtinlaten en toegang.
- De achterplaat moet worden geïnstalleerd terwijl de voorkant van de sensor in de beschermende verpakking blijft tot het systeem in gebruik wordt genomen.
- Pas op voor breekbare elektronica en connectorpinnen aan de achterkant van de sensorbehuizing.

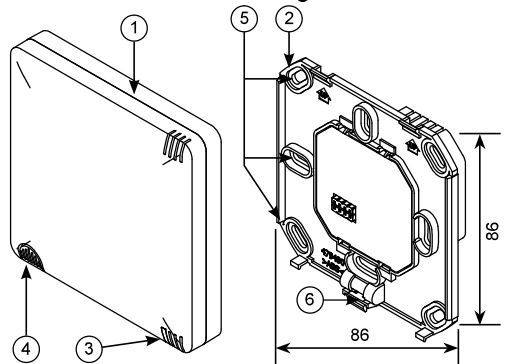





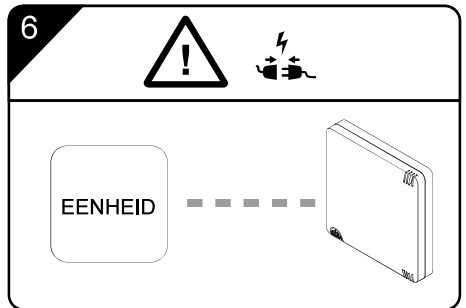
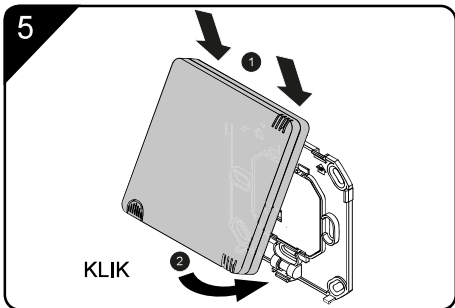
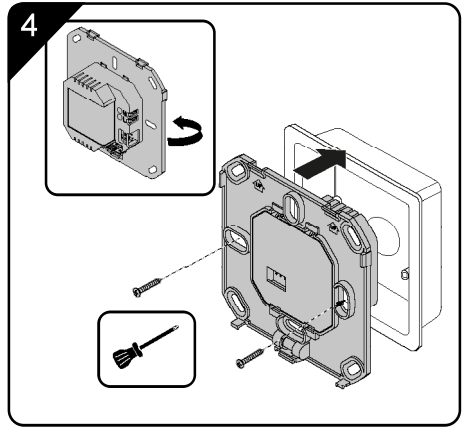
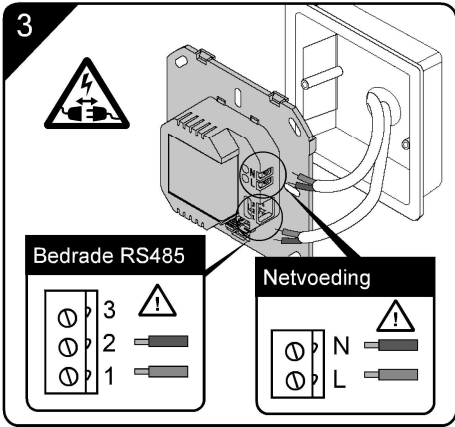
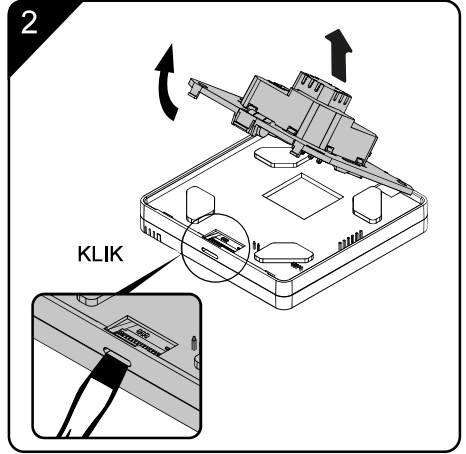
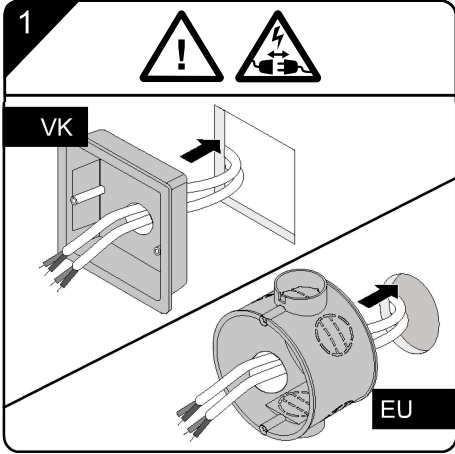
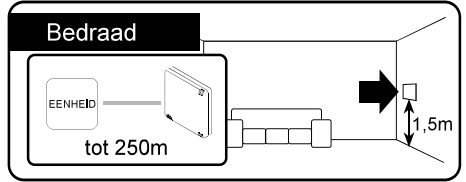
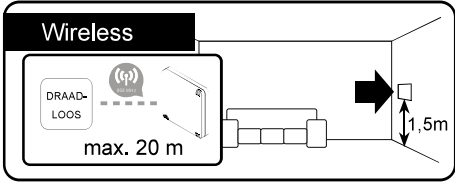

1. Behuizing met sensorelektronica
2. Grondplaat met voeding
3. LED (veelkleurig)



4. Drukknop
5. Bevestigingsgaten voor montage
6. Haak om in de behuizing te klikken.







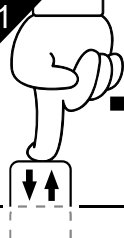

Legenda

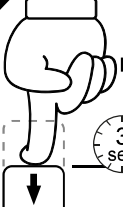

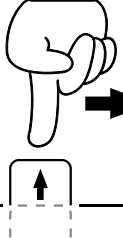
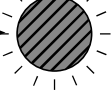
						
Groen	Rood	Continu blauw	Groen knipperend	Rood knipperend	Gekoppeld	Niet gekoppeld



A - Draadloze koppeling

A-1  →  



A-2  →    → 



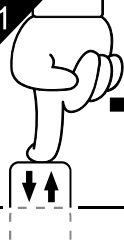

A-3   

→  





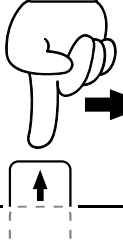

→   → **A-1**



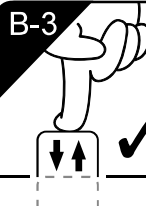

B - Reset

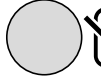
B-1  →  

B-2  →    → 

 ↓

B-3  ✓ →  →   →  

  →   → **B-1**

Technische gegevens

Functies	Waarden
Beschermingsklasse (EN 61140)	II
Soort bescherming (DIN EN 60529)	IP31
Ingangsspanning - Netspanning [V AC/Hz]	230/50
Bedrijfsspanning [V DC]	5
Stroomverbruik [W]	0,64
Stroomverbruik (in stand-by) [W]	0,41
Radiofrequentie [MHz]	868
Bereik van radionetwerk [m]	Vrije veld: 100 / gebouw: 20
Temperatuur van meetbereik [°C]	7 – 37
Meetbereik van luchtvochtigheid [%]	20 – 90
Afmetingen [H x B x D in mm]	90 x 90 x 17



Afvoer

Dit product mag niet met het gewone huisvuil worden afgevoerd. Indien mogelijk recycleren.
Controleer bij uw gemeente voor advies over recycleren.

VOOR CONTACTGEGEVENS VERWIJZEN WIJ U NAAR DE HANDLEIDING
VAN UW APPARAAT